

HM

HeatMaster®

Installation, Operating and Servicing Instructions

HeatMaster® 200 N

HeatMaster® 200 F



excellence in hot water

INTRODUCTION	1
Target group	1
Symbols	1
Certification	1
Information and safety instructions	2
USER GUIDE	2
Use of the boiler	2
DESCRIPTION	3
Operating principle	3
Packing	3
Construction features	4
TECHNICAL SPECIFICATION	5
Effective dimensions	5
General characteristics	5
Hot water output data	6
Limits of operating conditions	6
Burner chamber plate	6
INSTALLATION	7
Boiler room	7
Chimney connections	7
Hot water connections	8
Heating connection	9
Oil supply connections	9
Electrical connections	10
Wiring diagram	10
COMMISSIONING	11
Filling the hot water and heating circuits	11
MAINTENANCE	11
Service intervals	11
Servicing the boiler	11
Servicing the safety devices	11
Servicing the burner	11
Draining the boiler	12
SAFETY MODE	12
Placing the burner in safety mode	12
Placing the boiler in safety mode	12
SPARE PARTS	13
Jackets	13
Accessories	13
SERVICE RECORD	14
Details of the installation	14
Service notes	14

TARGET GROUP

This manual is intended for the use of:

- final users of the appliance;
- the engineer installing and starting up the appliance;
- the engineering and design department;
- the installer responsible for servicing or maintaining the appliance.

SYMBOLS

The following symbols are used in this manual:



Essential instruction for operating the system correctly.



Essential instruction for personal safety or environmental protection.



Danger of electrocution.

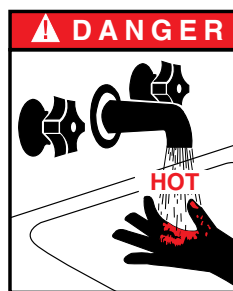

Risk of scalding.

CERTIFICATION

The appliances carry the “CE” mark, in accordance with the standards in force in the various countries (European Directive 92/42/CEE “Efficiency”).



GENERAL INFORMATION AND SAFETY INSTRUCTIONS

General information

This documentation forms part of the items delivered with the appliance and must be given to the user to keep in a safe place!

This appliance must be serviced and repaired by an approved installer, in accordance with current standards in force.

ACV declines all liability for any damage caused as a result of incorrect installation or as a result of the use of components or connections that are not approved by ACV for this application.

Temperatures



This boiler is designed for central heating systems with a maximum outlet temperature of 90°C. Therefore, the central heating pipelines and the radiators must reach this temperature.

The waste-gas pipe lines must reach temperatures in excess of 100°C.

The hot water can reach temperatures in excess of 60°C.

Installation



Before installing and commissioning the boiler, first carefully read this manual.

Position the **HeatMaster®** according to the safety rules and standards in force. You must comply with the ventilation requirements for the room where appliances of this type are installed. All air vents must remain unobstructed at all times.

It is prohibited to modify the interior of the appliance in any way, without the manufacturer's prior written agreement.

Service

In order to ensure the appliance operates safely and correctly, it is important to have it serviced and reconditioned every year by an installer or an approved service company.

Faults

Despite the strict quality standards imposed on its appliances by ACV during production, inspection, and transport, faults may occur. Please immediately inform your approved installer about such faults.

Only genuine factory parts may be used as replacement parts. Please go to page 13 for a list of spare parts and their ACV reference numbers.

Important note: ACV reserves the right to change the technical characteristics and specification of its products without notice.

USING THE BOILER



It is compulsory to have your system serviced every year by a competent engineer. In the event of heavy use of the boiler, it may require servicing on a more regular basis than once a year. In this case, contact your installer for advice.

Starting the burner

In conditions of normal operation, the burner starts automatically if the temperature of the boiler is below the set point and goes off when this value is reached.

Control panel

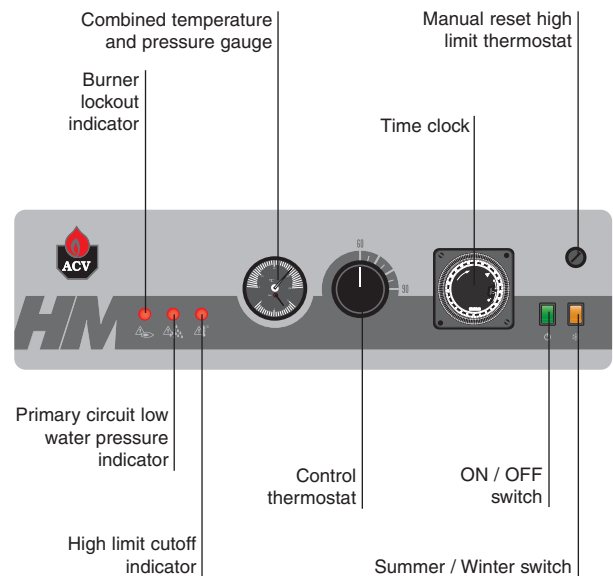

The user must not attempt to gain access to the components inside the control panel.

1. On/Off switch

This turns the HeatMaster on or off.

2. Control thermostat - 60 to 90°C

When using the **HeatMaster®** as a hot water generator only, the temperature can be set between 60°C and 90°C. If the **HeatMaster®** is used for both hot water and central heating, the control thermostat would normally be set at 80°C to achieve optimum operating conditions.

3. Summer/Winter switch

This turns the heating pump (if fitted) on or off.

4. Manual reset high limit thermostat

If the boiler temperature exceeds 103°C this safety device will activate and the high temperature indicator will light up. To reset - first allow the boiler to cool to below 60°C, unscrew the cap and press the reset button using a pencil or similar pointed device, replace the cap. If the fault persists, turn the boiler off and call an engineer.

5. Time clock

This allows the **HeatMaster®** to be timed on and off and operates on a 24 hour sequence. Around the outside of the clock there are a number of white tabs, these allow 15 minute switching periods. To set the time clock simply push outwards the number of tabs required for ON period.

Remember: TAB IN = HeatMaster OFF
 TAB OUT = HeatMaster ON

6. Temperature and pressure gauge

This gauge indicates both the temperature of the **HeatMaster®** and the pressure within the primary circuit.

The temperature should not exceed 90°C - if it does, switch the boiler off and check the thermostat setting. If the fault persists, call an engineer.

The pressure should not fall below 1bar, if it does the please see the 'Heating System Pressure' paragraph later in this section.

7. Low primary water pressure indicator

If this indicator lights up, the primary circuit of the **HeatMaster®** requires topping up with water. Please see the 'Heating System Pressure' paragraph later in this section.

Heating-system pressure

The heating circuit may require a top-up of water. The pressure gauge, located beside the display, gives the pressure.



In the case of repeated fills, contact your installer.

The pressure of the primary circuit must be at least 1 bar and must be regularly checked by the end user. If the pressure falls below 0.5 bar, the low-water-level pressure switch locks the appliance until the pressure in the system returns to above 0.8 bar.

The **HeatMaster® 200 N / 200 F** is fitted with a purpose-designed fill set (see Fig. A and B). Always make sure that the appliance is switched off when filling the system.

To do this, turn the On/Off switch on the left of the control panel to Off.

For more information, please ask your installer when delivering the system.

The appliance is fitted with a safety valve. If the system pressure exceeds 3 bars, this valve opens and drains the water from the system. In this case, contact your installer.

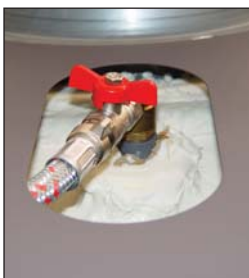

Fig. A
(cover)



Fig. B
(rear panel)

OPERATING PRINCIPLE

The **HeatMaster®** is a high performance, direct fired hot water storage heater, which has indirect heat transfer due to its Tank-in-Tank construction.

At the heart of the **HeatMaster®** is a stainless steel cylinder through which the flue tubes pass. This is surrounded by a mild steel shell containing the primary water (neutral fluid). The outer shell extends down to the combustion chamber and even around the flue tubes. The area of the heat transfer surface is therefore much greater than that of standard direct fired water heaters.

A circulating pump fitted to the primary circuit moves the water around the tank, heating it faster and maintaining an even temperature across the primary jacket.

The burner, either gas or oil, fires onto the primary water which indirectly heats the stainless steel cylinder containing the DHW. As with all Tank-in-Tanks, this is corrugated over its full height and suspended in the **HeatMaster®** by its hot and cold water connections.

The cylinder expands and contracts during use and this, together with the fact that cold water does not come into contact with the intense heat of the burner flame, means that limescale buildup is prevented.

This scale resistant feature, along with the corrosion resistance of stainless steel, eliminates the need for sacrificial anodes.

The **HeatMaster®** has one very major advantage over other direct fired water heaters - because it heats the DHW with a primary circuit, this primary water can be used to provide central heating as well.

By connecting two, three, four or more **HeatMaster®** together in a module, most hot water and heating demands can be met.

Indeed, when used in conjunction with HR and **Jumbo** hot water storage tanks the **HeatMaster** can supply even the largest hot water requirement.

Standard equipment

The **HeatMaster 200** has the following items as standard:

- On/off switch
- Summer/Winter switch
- Control thermostat (60 - 90°C)
- Thermal reset high-limit thermostat (95°C)
- Manual reset high-limit thermostat
- Hot water priority thermostat
- Primary circulating shunt pump
- Primary expansion vessels
- Primary safety valve
- Pressure and temperature gauge
- Drain valve
- Body completely insulated in rigid polyurethane foam

PACKING

The **HeatMaster** is delivered in separate packages.

- Package No. 1: Foam-insulated body, hydraulic accessories, and control panel.
- Package No. 2: Chimney reducing pipe.
- Package No. 3: Wooden protective casing (jacket and accessory).
- Package No. 4: "RIELLO" RG4S 396 T1 burner (*HM 200 F only*).

DESCRIPTION

CONSTRUCTION FEATURES

Outer body

The outer body, containing the primary water, is made from STW 22 carbon steel.

TANK-IN-TANK heat exchanger

The ring-shaped inner tank with its large heating surface for producing domestic hot water is built of Chrome/Nickel 18/10 stainless steel. It is corrugated over its full height by an exclusive production process and entirely argon arc welded by the TIG (Tungsten Inert Gas) method.

Combustion gas circuit

The combustion gas circuit is paint-protected and comprises:

- **Flue pipes**

Depending on output, **HeatMaster® 200** models contain several steel flue pipes with an internal diameter of 64 mm. Each pipe is fitted with a baffle of special steel designed to improve heat exchange and reduce flue gas temperature.

- **Combustion chamber**

The combustion chamber on **HeatMaster®** models is entirely water cooled.

Insulation

The boiler body is fully insulated by rigid polyurethane foam with a high thermal insulation coefficient, sprayed on without the use of CFCs.

Casing

The boiler is covered by a steel jacket which has been scoured and phosphated before being stove enamelled at 220°C.

Burner

The **HM 200 F** model is always delivered with a "RIELLO" RG4S 396 T1 fuel oil burner.

Legend

1. "Tank-in-Tank" type storage exchanger
2. Flue ways
3. Primary circuit
4. Combustion chamber
5. Turbulators
6. Heating outlet
7. Stainless steel pocket
8. Heating return
9. Boiler drain cock
10. Hot water priority thermostat bulb
11. Cold water inlet
12. Bulbs of the thermal reset high-limit 95°C thermostat and the manual reset high-limit 103°C thermostat
13. Insulation
14. Low-water-level pressure switch
15. Hot water outlet
16. Chimney reducer
17. Steam trap
18. T&P valve (optional)
19. Thermostat-pressure gauge bulb
20. 60 - 90°C control thermostat bulb
21. Flange of the burner chamber plate

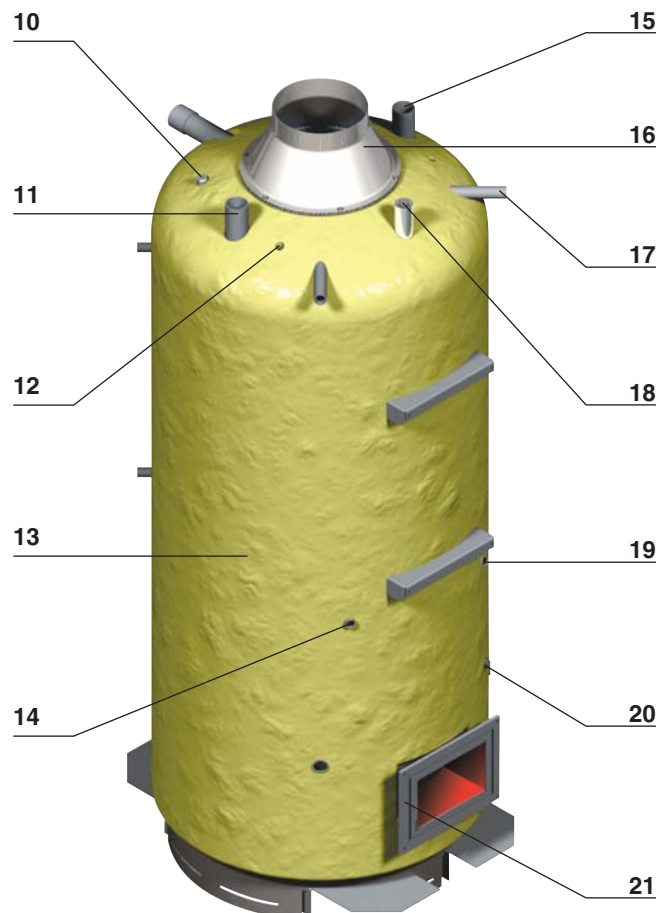
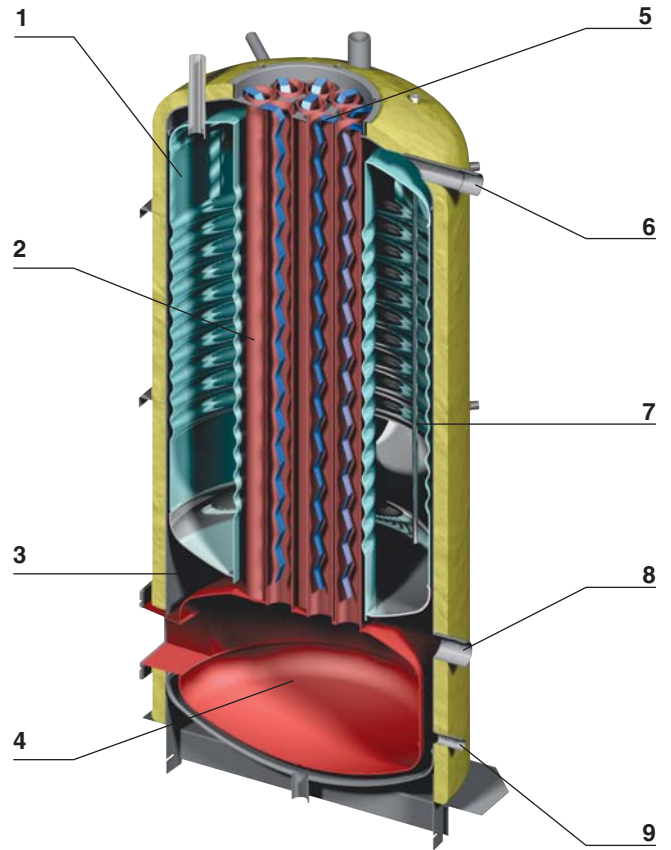

EFFECTIVE DIMENSIONS

The appliances delivered are factory-tested. Upon receipt, remove the packing and check that there is no damage to the appliances. Refer to the dimensions and weights listed below for transport purposes.

The jacket is fitted by the installer on site (*see the assembly instructions in the wooden protective casing*).

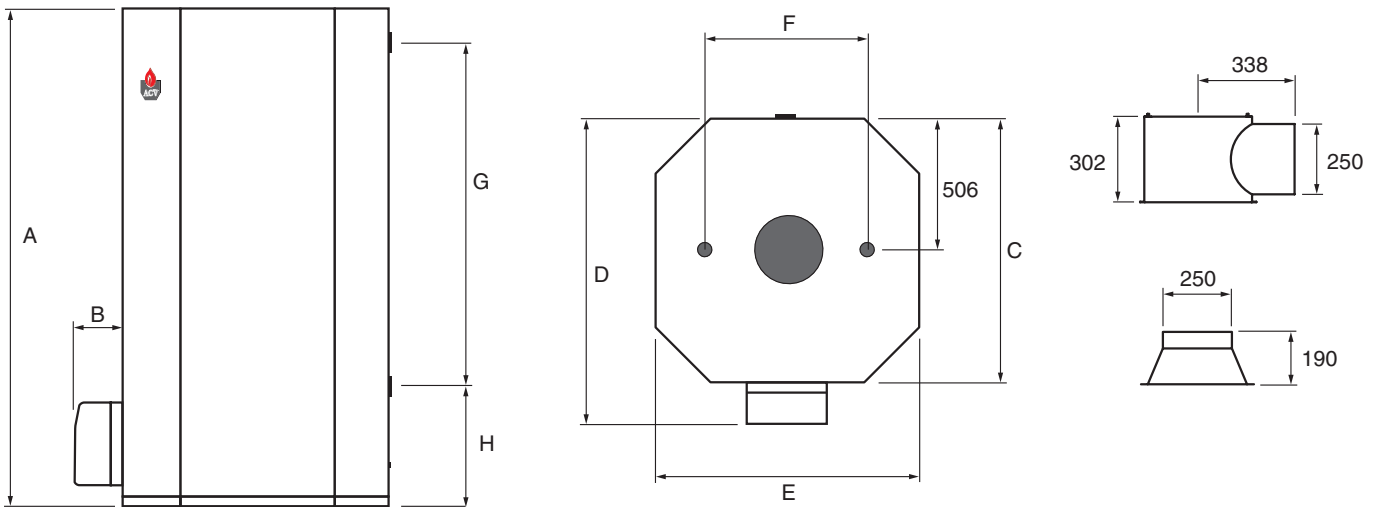

	A mm	B mm	C mm	D mm	E mm	F mm	G mm	H mm
HeatMaster® 200 N	2085	-	1020	-	1020	600	1383	590
HeatMaster® 200 F	2085	190	1020	1210	1020	600	1383	590

GENERAL CHARACTERISTICS

		HM 200 N	HM 200 F
Fuel	type	Fuel / Gas	Fuel
Input	kW	154.0	196.0
Output	kW	141.7	180.3
Maintenance loss of nominal value at 60°C	%	0.43	0.34
Total capacity	L	641	641
Primary circuit capacity	L	241	241
Hot water connection	Ø	2"	2"
Heating connection	Ø	2"	2"
Chimney connection	Ø mm	250	250
Water tank heat transfer surface	m²	5.30	5.30
Drained weight	Kg	530	550
Pressure loss of the primary circuit	mbar	240	240
Combustion efficiency	%	93.5	93.7
Output CO ₂	%	12.8	12.9
Net temperature of the flue gases	°C	143	140.5
Mass flow rate of combustion products	g/sec.	65.2	83.0
Nozzle (<i>Fuel oil</i>)	gal/h	3.25 / 60° B	4.00 / 60° B
Pump pressure (<i>Fuel oil</i>)	bar	11.0	11.6

(*) The HeatMaster® 200F outputs can only be reached if the boiler is fitted with a "RIELLO" RG4S 396 T1 fuel oil burner.

TECHNICAL SPECIFICATION

DOMESTIC HOT WATER PERFORMANCES

		HM 200 N	HM 200 F
Peak delivery at 40°C	L/10'	1570	1675
Peak delivery at 45°C	L/10'	1350	1444
Peak delivery at 60°C	L/10'	915	961
Peak delivery at 70°C	L/10'	737	755
Peak delivery at 80°C	L/10'	586	586
Peak delivery at 40°C	L/60'	4920	5976
Peak delivery at 45°C	L/60'	4221	5131
Peak delivery at 60°C	L/60'	2925	3126
Peak delivery at 70°C	L/60'	2412	2309
Peak delivery at 80°C	L/60'	1712	1712
Continuous delivery at 40°C	L/h	4020	5161
Continuous delivery at 45°C	L/h'	3446	4424
Continuous delivery at 60°C	L/h'	2412	2598
Continuous delivery at 70°C	L/h'	2010	1864
Continuous delivery at 80°C	L/h'	1352	1352

N.B.:

The outputs above are given for a hot water temperature of 90°C and a cold water temperature of 10°C.

MAXIMUM OPERATING CONDITIONS

Maximum service pressure (tank full of water)

- Primary circuit: 3 bar
- Secondary circuit: 10 bar

Test pressure (tank full of water)

- Primary circuit: 4.5 bar
- Secondary circuit: 13 bar

Operating temperature

- Maximum temperature: 90°C

Water quality

- Chlorures: < 150 mg/l (304)
< 2000 mg/l (Duplex)

- $6 \leq \text{ph} \leq 8$

BURNER CHAMBER PLATE

The burner chamber plate secures the burner with 4 screw threads (M 8). It is thermally insulated to protect it from the heat.

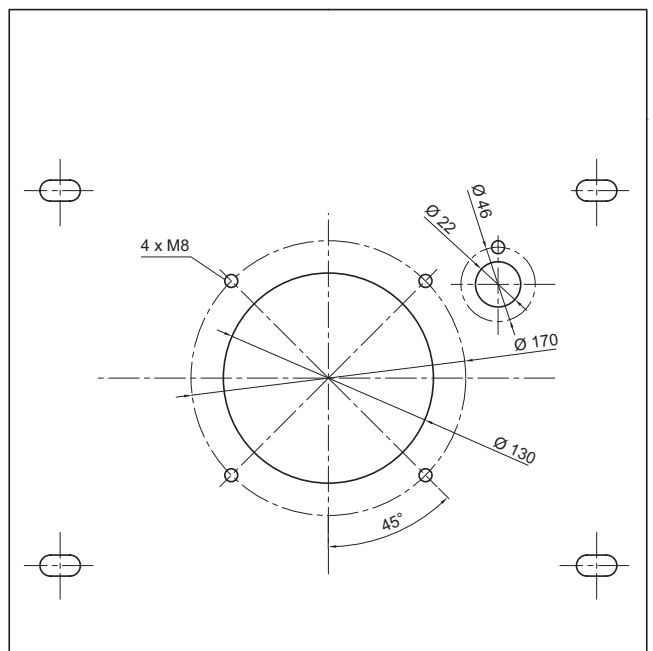

BOILER ROOM

Important

- Keep vents free at all times.
- Do not store inflammable products in the boiler room.
- Do not store corrosive products near the boiler, such as paints, solvents, chlorine, salt, soap and other cleaning products.
- If you smell gas, do not switch on the light or light a flame. Turn off the mains gas tap at the meter and inform the appropriate services immediately.

Access

The boiler room must be large enough to allow good access to the boiler. The following minimum distances are required around the boiler:

- front 500 mm
- side 100 mm
- behind 150 mm
- above 350 mm

Ventilation

The boiler room must have both low- and high-level ventilation, in accordance with the local standards and provisions force.

The table below gives an example conforming to the Belgian standards.

Ventilation		200 N	200 F
Min. fresh air requirement	m ³ /h	277	353
Bottom	dm ²	2.45	2.45
Top	dm ²	4.62	5.88

Other countries should refer to their own standards.

Base

The base on which the boiler rests must be made of non-combustible materials.

CHIMNEY CONNECTIONS



IMPORTANT

Boilers must be installed by an approved heating engineer, in accordance with the prevailing local standards and regulations.



The duct size may not be smaller than the boiler outlet duct.

Typical boiler connection: B23

The boiler is connected to the chimney by a metal pipe rising at an angle from the boiler to the chimney.

A flue disconnection piece is required.

This must be easy to remove to give access to the flue pipes when servicing the boiler.

Chimney / minimum flue diameter		200 N	200 F
E = 5 m	Ø F min.	mm 284	320
E = 10 m	Ø F min.	mm 250	269
E = 15 m	Ø F min.	mm 250	250



Note:

Regulations vary from country to country therefore the table above is intended only as a guide.



Due to the high efficiency of our boilers, the flue gasses exit at low temperature. Accordingly, there is risk that the flue gasses could condense, which could damage the chimney. In order to avoid this risk, it is strongly recommended that the chimney be lined.

A condensation drain outlet must be fitted close to the boiler to prevent condensation products from the chimney running into the boiler.

To avoid condensation water running out of the terminal, all horizontal flue runs must fall back towards the boiler.

- A. Top vent
- B. Bottom vent
- C. Draught regulator
- D. Inspection window
- E. Height of lined chimney
- F. Chimney diameter

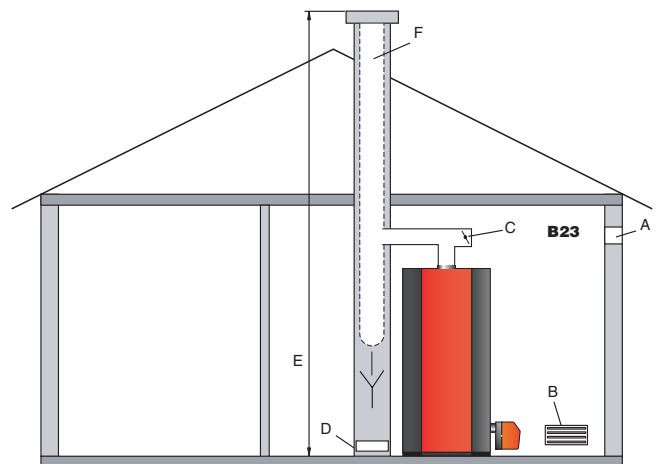

When connecting the flue-gas outlet to an existing chimney, do not take into account the pressure drop on the "flue gas side".

INSTALLATION

HOT WATER CONNECTIONS

Pressure reducing valve

If the mains water pressure is greater than 6 bar, a pressure reducing valve must be fitted.

Expansion relief valve

The tank expansion relief valve must be ACV approved and calibrated to a maximum of 7 bar. The valve discharge must be connected to the drain.

Hot water expansion vessel

We recommend installing a hot water expansion vessel.

Hot water circulation

If the tank is situated a long way from the point of use, then installing a recirculation loop can provide a faster supply of hot water to the outlets.

Temperature and pressure relief valve

If using the HeatMaster as an unvented hot water unit, in some countries, a temperature and pressure relief valve must be fitted - consult your ACV stockist for assistance.

Example of hot water connection with thermostatic mixer

1. Stop cock
2. Non-return valve
3. Pressure reducing valve
4. Expansion relief valve
5. Hot water expansion vessel
6. Hot water secondary pump (if fitted)
7. Thermostatic mixing valve
8. Drawoff tap
9. Drain cock
10. Stop cock for cleaning
11. Temperature relief valve (UK-only)

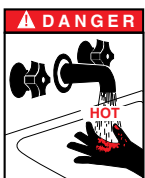
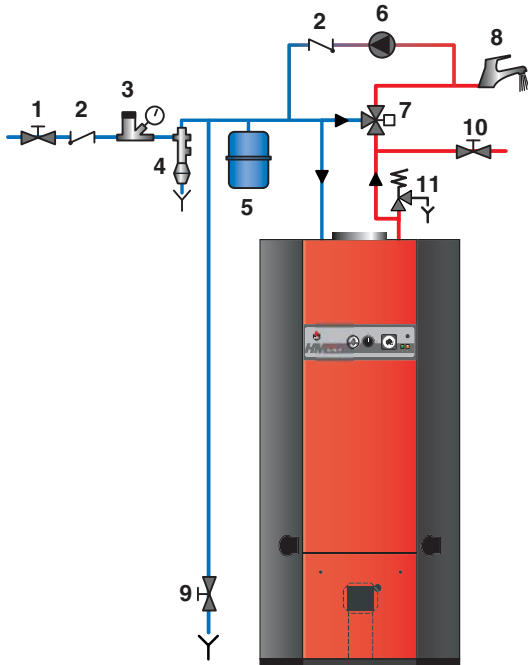

DANGER!
As a safety measure, we strongly advise installing a thermostatic mixer to prevent the risk of burns

Example of parallel connection

Recommended for applications with a high continuous flow.

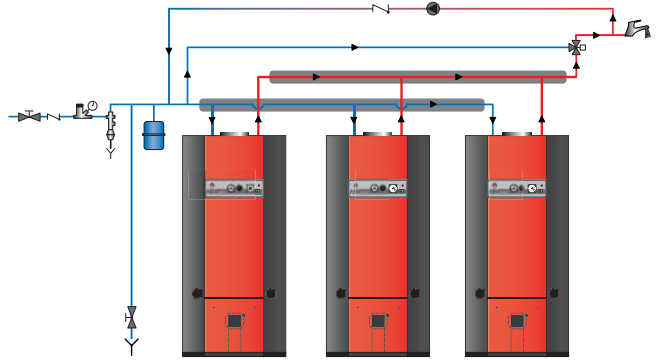

Example of series connection

Preferable for high temperature applications with up to three units.

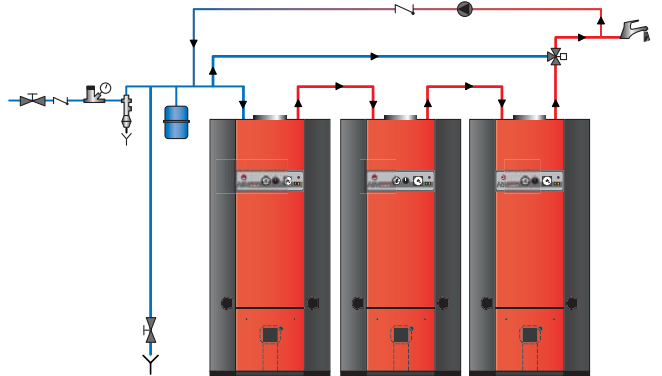

Example of heating + storage connection

Recommended for applications requiring a high peak flow.

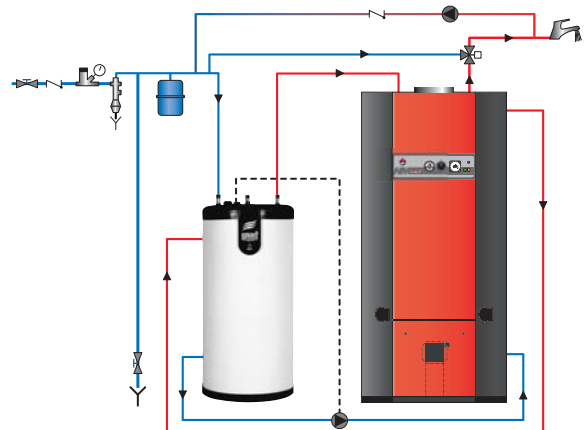

HEATING CONNECTION

The **HeatMaster®** has two connections at the rear that can be used to connect a central heating circuit. Connecting a heating system may reduce the domestic hot water performance.

Expansion

The **HeatMaster®** 200 models are equipped with 4 8-litre expansion vessels. These expansion vessels are sized for hot water operation only. If a heating system is connected to the primary circuit, calculate the expansion capacity necessary for the total volume of the heating system. (Refer to the technical instructions from a relevant manufacturer of expansion vessels).

Example of a single circuit connection

1. 4-way valve
2. Heating pump
3. Non-return valve
4. Isolating valves
5. Safety valve set to 3 bar with pressure gauge
6. Expansion vessel
7. Drain cock
8. Controller (optional)
9. Surface-mounted sensor (optional)

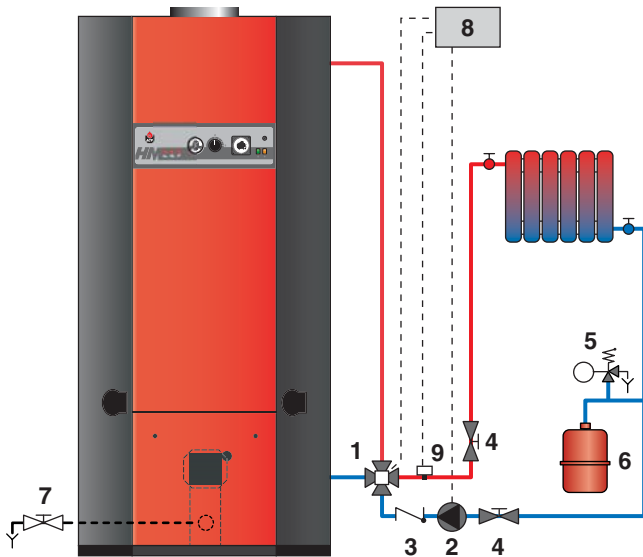

WARNING

The primary safety valve is supplied with a plastic tube connected to the discharge outlet - this is for test purposes only and should be removed. The safety valve should be connected to a drain using a metallic pipe eg. copper.

BEWARE

In the case of heating at low temperature, the use of the kit (code: 10800099) is required.

FUEL OIL SUPPLY CONNECTION

(If another make of burner is fitted please refer to that manufacturer's technical manual.)

Installation without return

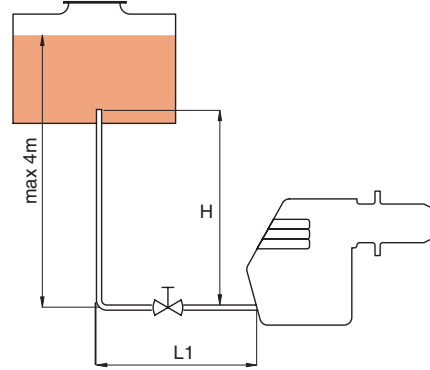

	L (m) (L = H + L1)	
H (m)	Ø int. 8 mm	Ø int. 10 mm
0.5	10	20
1	20	40
1.5	40	80
2	60	100

Installation with return

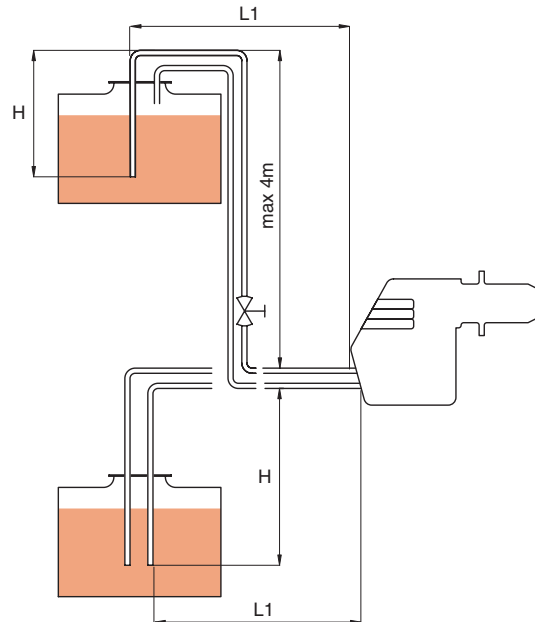

	L (m) (L = H + L1)	
H (m)	Ø int. 8 mm	Ø int. 10 mm
0	35	100
0.5	30	100
1	25	100
1.5	20	90
2	15	70
2	8	30
3.5	6	20

INSTALLATION

ELECTRICAL CONNECTIONS

Electrical supply

The boiler operates with a 230 V - 50 Hz single phase supply. A double pole isolator with a 6 amp fuse or a 6 amp circuit breaker switch to cut the power supply when servicing or repairing the boiler.

Conformity

Boiler installation must comply with the prevailing local standards and legislation.

Safety

The stainless steel tank must be earthed separately.



The power to the boiler must be switched off before any work is carried out.

WIRING DIAGRAM

HeatMaster® wiring diagram legend 200 N / 200 F

1. 230 V power connection plug
2. On/off switch
3. Temperature high limit cutoff indicator
4. Manual reset high limit thermostat
5. Primary circuit low water pressure indicator
6. Low water pressure switch
7. Time clock
8. Summer/winter switch
9. Hot water priority link
10. Burner lockout indicator
11. Room thermostat connection (option)
12. Central heating pump
13. HeatMaster shunt pump
14. Burner plug connector
15. Water flow switch connection (option)
16. Thermal reset high limit thermostat 95°C
17. Control thermostat

Electrical connection HeatMaster® 200 N / 200 F

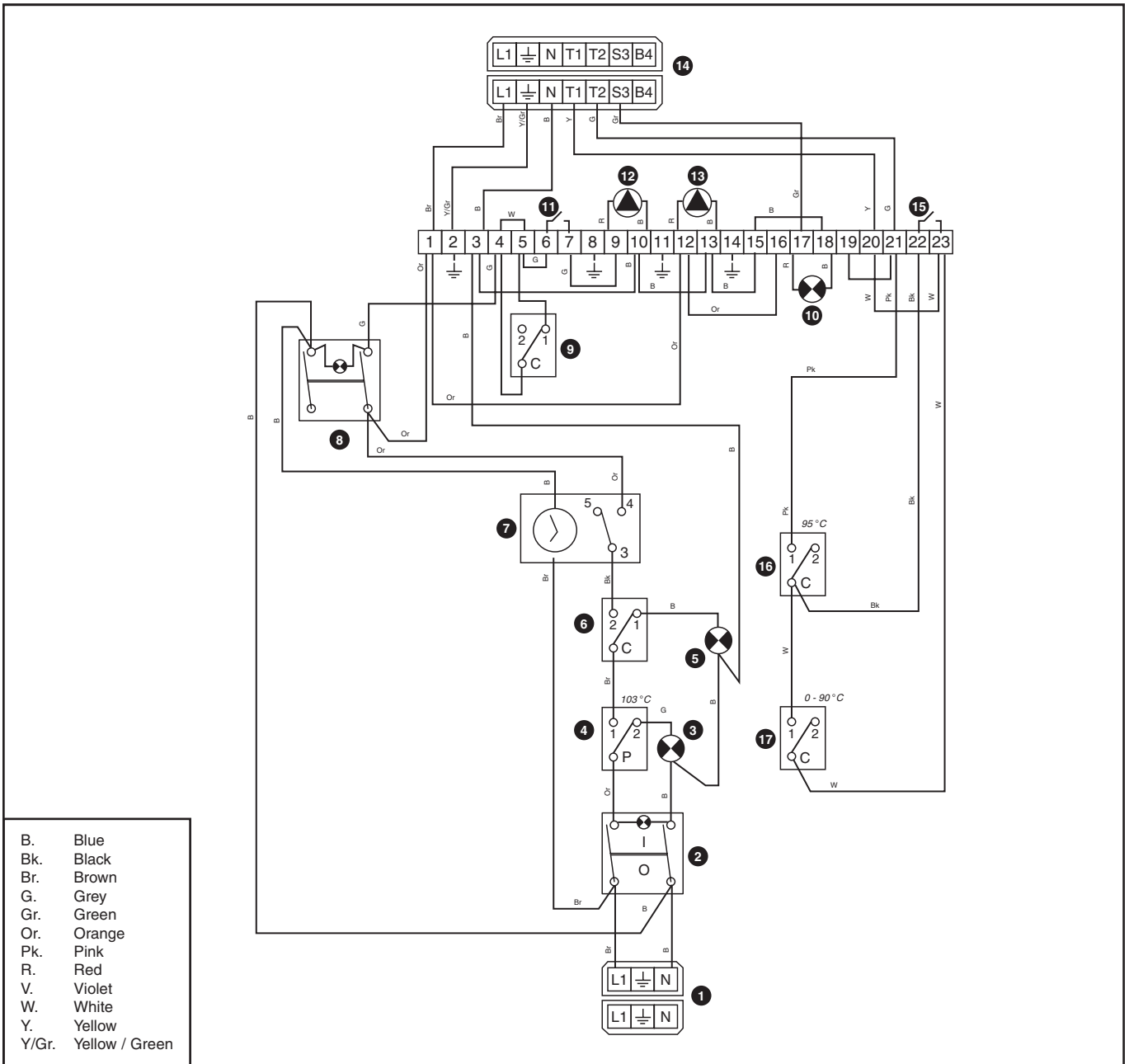

FILLING THE HOT WATER AND HEATING CIRCUITS



IMPORTANT
Hot water tank must be pressurised before the heating circuit is filled.

1. Close the fill valves for the heating circuit (A and B).
2. Open the stop valve (1) and draw-off tap (8).
Fill the tank with the water from the tap; close the draw-off tap (8).
3. Fill the primary heating circuit by opening the fill valves (A and B), taking care not to exceed 1 bar of pressure.



A



B

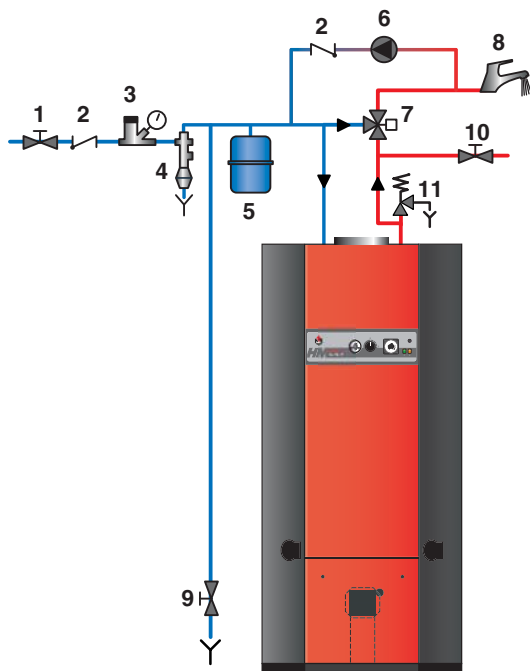

4. Open the automatic air vent located on top of the boiler.
Important: You must not excessively tighten the threaded plug to allow automatic bleeding.
5. After venting the air from the system, bring the pressure up to the static head plus 0.5 bar: 1.5 bar = 10m and 2 bar = 15 m.
6. Check the electrical connection and the ventilation in the boiler room.
7. Move the main switch to "ON".
8. Set the thermostat to the desired temperature.
9. When the burner is on, check that the flue-gas discharge pipes are completely gas tight.
10. After operating for five minutes, turn off the boiler and drain the heating circuit again, maintaining a pressure of 1 bar.
11. Turn the appliance back on and check the combustion (see table page 5).

SERVICE INTERVALS

ACV recommends that boilers should be serviced at least once a year. The burner must be serviced and tested by a competent engineer. In the event of heavy use of the boiler, it may require servicing on a more regular basis than once a year. In this case, contact ACV for advice.

SERVICING THE BOILER

1. Set the main switch on the control panel to OFF and cut the outside power supply.
2. Close the valve supplying gas to the boiler.

Vertical flue-gas outlet reducer

3. Take down and remove the flue lining to release the top of the boiler.
4. Loosen the nuts and remove the chimney reducer.
5. Take out the turbulators from the flue ways to clean them.
6. Dismantle the chamber plate and remove the burner.
7. Brush the flue ways.
8. Clean the combustion chamber and the burner.
9. Replace the turbulators, the chimney reducer, and the flue lining; check that the seal on the chimney reducer is in good condition. Replace the seal if necessary.

Horizontal flue-gas outlet reducer

3. Loosen the nuts and remove the chimney reducer.
5. Take out the turbulators from the flue ways to clean them.
6. Dismantle the chamber plate and remove the boiler.
7. Brush the flue ways.
8. Clean the combustion chamber and the burner.
9. Replace the turbulators, the chimney reducer, and the flue lining; check that the seal between the chimney reducer and the chimney is in good condition. Replace the seal if necessary.

SERVICING THE SAFETY DEVICES

- Check that all thermostats and safety devices are working properly.
- Test the safety valves on the central heating and hot water circuits.

SERVICING THE BURNER

- Check that the insulation and the seal on the chamber plate are in good condition; replace them if necessary.
- Check and clean the burner.
- Check that the safety devices are in good working order.
- Check the combustion (CO₂, CO) and record the values and any other comments on page 15 of the service record.

DRAINING THE BOILER



Water flowing out of the drain cock may be extremely hot and could cause severe scalding. Keep people away from discharges of hot water.

Draining the heating circuit

1. Put the main switch on the control panel to OFF, cut the outside power supply and close the gas or fuel supply valve to the boiler.
2. Close the isolating valves (4) or manually set the 4-way valve (1) to "0".
3. Connect a flexible tube to the drain cock (7). Make sure it is properly connected.
4. Open the drain cock and allow the hot water to flow into the drain.

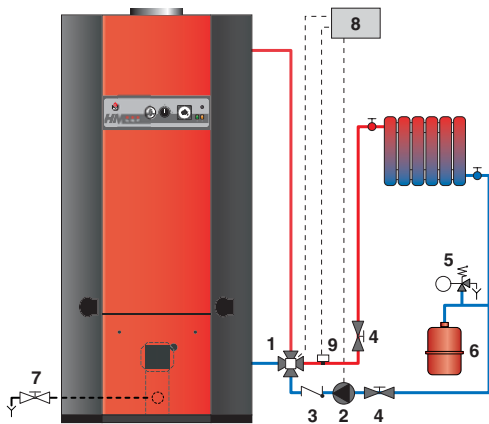

Drain the hot water circuit

1. Turn OFF the on/off switch on the boiler control panel, isolate external electrical supply, and turn off the gas or oil supply to the boiler.
2. Release the pressure in the heating circuit until the pressure gauge indicates zero bar.
3. Close stop cock (1) and turn off tap (8).
4. Open valve (9) then valve (10).
5. Let the water empty into the drain.

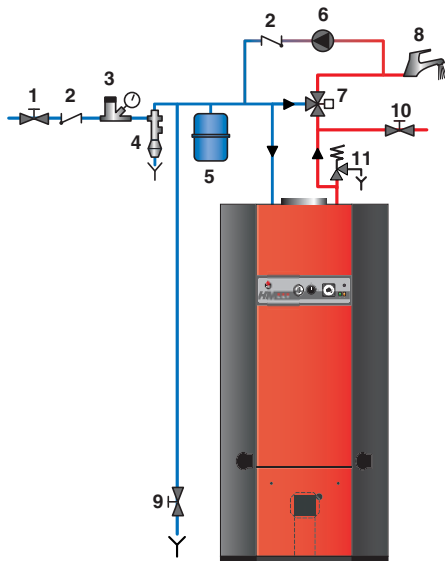

For the tank to be emptied, valve (9) must be situated at ground level.

PLACING THE BURNER IN SAFETY MODE

When the burner is in safety mode, the safety indicator located on the burner and the control panel lights up.

The red warning light indicates an operating fault. Wait one minute before rearming the burner by pressing the button on the burner.

If the burner does not relight, call the service engineer after ensuring that the fault is not due to a power cut or low oil in the tank.

PLACING THE BOILER IN SAFETY MODE

When the high-limit thermostat indicator light on the control panel comes on: rearm the manual reset high-limit thermostat.

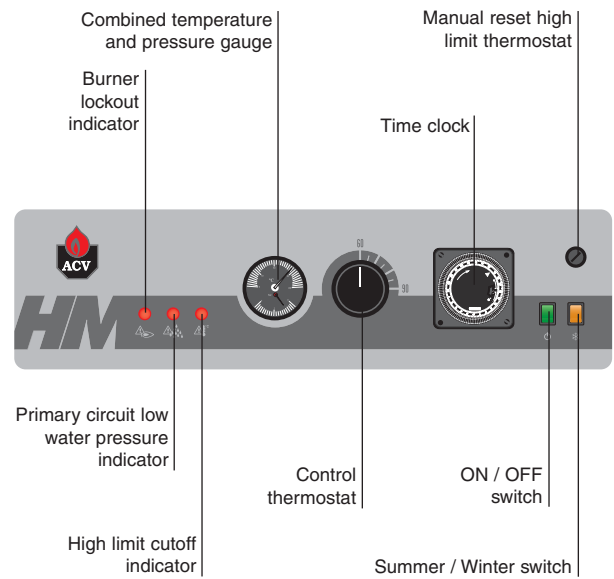

If the anomaly persists, contact your engineer.

SERVICE RECORD

INSTALLATION DETAILS

Date installed:	Model:
% CO ₂ (max. load):	Serial number:
Flue gas T°:	Heating system pressure setting:
Efficiency:	Name and signature:
Fuel oil pressure:	

SERVICE RECORD

Date installed:	Remarks:
% CO ₂ (max. load):	
Flue gas T°:	
Efficiency:	Name and signature:
Fuel oil pressure:	

Date installed:	Remarks:
% CO ₂ (max. load):	
Flue gas T°:	
Efficiency:	Name and signature:
Fuel oil pressure:	

Date installed:	Remarks:
% CO ₂ (max. load):	
Flue gas T°:	
Efficiency:	Name and signature:
Fuel oil pressure:	

Date installed:	Remarks:
% CO ₂ (max. load):	
Flue gas T°:	
Efficiency:	Name and signature:
Fuel oil pressure:	

Date installed:	Remarks:
% CO ₂ (max. load):	
Flue gas T°:	
Efficiency:	Name and signature:
Fuel oil pressure:	

Date installed:	Remarks:
% CO ₂ (max. load):	
Flue gas T°:	
Efficiency:	Name and signature:
Fuel oil pressure:	

Date installed:	Remarks:
% CO ₂ (max. load):	
Flue gas T°:	
Efficiency:	Name and signature:
Fuel oil pressure:	

Date installed:	Remarks:
% CO ₂ (max. load):	
Flue gas T°:	
Efficiency:	Name and signature:
Fuel oil pressure:	

Date installed:	Remarks:
% CO ₂ (max. load):	
Flue gas T°:	
Efficiency:	Name and signature:
Fuel oil pressure:	

Date installed:	Remarks:
% CO ₂ (max. load):	
Flue gas T°:	
Efficiency:	Name and signature:
Fuel oil pressure:	

Date installed:	Remarks:
% CO ₂ (max. load):	
Flue gas T°:	
Efficiency:	Name and signature:
Fuel oil pressure:	

SERVICE RECORD

Date installed:	Remarks:
% CO ₂ (max. load):	
Flue gas T°:	
Efficiency:	Name and signature:
Fuel oil pressure:	

Date installed:	Remarks:
% CO ₂ (max. load):	
Flue gas T°:	
Efficiency:	Name and signature:
Fuel oil pressure:	

Date installed:	Remarks:
% CO ₂ (max. load):	
Flue gas T°:	
Efficiency:	Name and signature:
Fuel oil pressure:	

Date installed:	Remarks:
% CO ₂ (max. load):	
Flue gas T°:	
Efficiency:	Name and signature:
Fuel oil pressure:	

Date installed:	Remarks:
% CO ₂ (max. load):	
Flue gas T°:	
Efficiency:	Name and signature:
Fuel oil pressure:	

Date installed:	Remarks:
% CO ₂ (max. load):	
Flue gas T°:	
Efficiency:	Name and signature:
Fuel oil pressure:	





excellence in hot water

www.acv-world.com

INTERNATIONAL

ACV international n.v
KERKPLEIN, 39
B-1601 RUIJSBROEK - BELGIUM
TEL.: +32 2 334 82 20
FAX: +32 2 378 16 49
E-MAIL: international.info@acv-world.com

BELGIUM

ACV BELGIUM nv/sa
KERKPLEIN, 39
B-1601 RUIJSBROEK-BELGIUM
TEL.: +32 2 334 82 40
FAX: +32 2 334 82 59
E-MAIL: belgium.info@acv-world.com

CHILE

ALBIN TROTTER Y ACV LTDA
SAN PABLO 3800
QUINTA NORMAL - SANTIAGO - CHILE
TEL.: +56 2 772 01 69
FAX: +56 2 772 92 62/63
E-MAIL: chile.info@acv-world.com

CZECH REPUBLIC

ACV CR SPOL. s.r.o
NA KRECKU 365
CR-109 04 PRAHA 10 - CZECH REPUBLIC
TEL.: +420 2 720 83 341
FAX: +420 2 720 83 343
E-MAIL: ceskarepublika.info@acv-world.com

DEUTSCHLAND

ACV WÄRMETECHNIK GMBH & CO KG
GEWERBEGBIET GARTENSTRASSE
D-08132 MÜLSEN OT ST. JACOB - DEUTSCHLAND
TEL.: +49 37601 311 30
FAX: +49 37601 311 31
E-MAIL: deutschland.info@acv-world.com

ESPAÑA

ACV ESPAÑA
C/DE LA TEIXIDORA, 76
POL. IND. LES HORTES
E-08302 MATARÓ - ESPANA
TEL.: +34 93 759 54 51
FAX: +34 93 759 34 98
E-MAIL: spain.info@acv-world.com

ARGENTINA

TECNO PRACTICA
ALFEREZ BOUCHARD 4857
1605 CARAPACHAY - BUENOS AIRES
TEL.: +54 11 47 65 33 35
FAX: +54 11 47 65 43 07
E-MAIL: jchas@tecnopractica.com

AUSTRALIA

HUNT HEATING PTY LTD
10 GARDEN BOULEVARD
3172 VICTORIA - AUSTRALIA
TEL.: +61 3 9558 7077
FAX: +61 3 9558 7027
E-MAIL: enquiries@huntheat.com.au

BRAZIL

SIMETAL INDUSTRIA E COMERCIO DE FERRAMENTAS LTDA
RUA GERSON ANDREIS 535
95112 - 130 CAXIAS DO SUL - BRAZIL
TEL.: +55 54 227 12 44
FAX: +55 54 227 12 26
E-MAIL: export@simetall.com.br

BULGARIA

PROXIMUS ENGINEERING LTD
7 BIAL KREM STR.
9010 VARNNA - BULGARIA
TEL.: +359 52 500 070
FAX: +359 52 301 131
E-MAIL: info@proximus-bg.com

CHINA

BEIJING HUADIAN HT POWER TECHNOLOGY DEVELOPMENT CO. LTD
ROOM B-912, TOWER B, COFCO PLAZA
N°. 8, JIANGUOMENNEI AVENUE
BEIJING 100005 - PEOPLE'S REPUBLIC OF CHINA
TEL.: +86 10 652 30 363/393 EXT 101
FAX: +86 10 652 27 071
E-MAIL: li.zheng@acv-world.com

SHANGHAI COOLTECH LTD

14/F E. CHINA MERCHANTS PLAZA
N°. 333 CHENGDU ROAD (N)
200041 SHANGHAI - CHINA
TEL.: +86 21 52 98 11 22 - 820
FAX: +86 21 52 98 13 58
E-MAIL: cooltech@cooltech.sh.cn

FRANCE

ACV FRANCE sa
31, RUE AMPERE - Z.I MI - PLAINE
F-69680 CHASSIEU - FRANCE
TEL.: +33 4 72 47 07 76
FAX: +33 4 72 47 08 72
E-MAIL: france.info@acv-world.com

ITALIA

ACV ITALIA
VIA PANA 92
I-48018 FAENZA (RA) - ITALIA
TEL.: +39 0546 64 61 44
FAX: +39 0546 64 61 50
E-MAIL: italia.info@acv-world.com

NEDERLAND

ACV NEDERLAND bv
POSTBUS 350
NL-2980 AJ RIDDERKERK - NEDERLAND
TEL.: +31 180 42 10 55
FAX: +31 180 41 58 02
E-MAIL: nederland.info@acv-world.com

POLAND

ACV POLSKA sp. z o.o.
UL. WITOSA 3
87 - 800 WŁOCŁAWEK - POLAND
TEL.: +48 54 412 56 00
FAX: +48 54 412 56 01
E-MAIL: polska.info@acv-world.com

PORTUGAL

BOILERNOX LDA
RUA OUTEIRO DO POMAR
CASAL DO CEGO, FRACÇÃO C,
PAVILHÃO 3 - MARRAZES
2400-402 LEIRIA - PORTUGAL
TEL.: +351 244 837 239/40
FAX: +351 244 823 758
E-MAIL: boilernox@mail.telepac.pt

RUSSIA

ACV RUSSIA
1/9, MAL'YI KISEL'NYI
103031 MOSCOW - RUSSIA
TEL.: +7 095 928 48 02 / +7 095 921 89 79
FAX: +7 095 928 08 77
E-MAIL: russia.info@acv-world.com

DENMARK

VARMHUSSET
FRICHSVEJ 40 A
8600 SILKEBORG - DENMARK
TEL.: +45 86 82 63 55
FAX: +45 86 82 65 03
E-MAIL: vh@varmhusset.dk

ESTONIA

TERMOMX AS
TAHE 112A
51013 TARTU - ESTONIA
TEL.: +372 736 73 39
FAX: +372 736 73 44
E-MAIL: termomx@termomx.ee

GREECE

ESTIAS
MARASLI STREET 7
54248 THESSALONIKI - GREECE
TEL.: +30 23 10 31 98 77 / +30 23 10 32 03 58
FAX: +30 23 10 31 97 22
E-MAIL: info@genikithermanseon.gr

ÎLE MAURICE

SOTRATECH
29, RUE MELDRUM
BEAU BASSIN - ÎLE MAURICE
TEL.: +230 46 76 970
FAX: +230 46 76 971
E-MAIL: stech@intnet.mu

LITHUANIA

UAB "GILIUS IR KO"
SAVARNORIŲ PR. 192
3000 KAUNAS - LITHUANIA
TEL.: +370 37 308 930
FAX: +370 37 308 932

MAROC

CASATHERM
PLACE EL YASSIR
20300 CASABLANCA - MAROC
TEL.: +212 22 40 15 23
FAX: +212 22 24 04 86

SLOVAK REPUBLIC

ACV SLOVAKIA s.r.o.
PLUHOVÁ 49
831 04 BRATISLAVA - SLOVAK REPUBLIC
TEL.: +421 2 444 62 276
FAX: +421 2 444 62 275
E-MAIL: slovakia.info@acv-world.com

SLOVENIA

ACV D.O.O. SLOVENIA
OPEKARNA 22b
1420 TRBOVLJE - SLOVENIA
TEL.: +386 356 32 830
FAX: +386 356 32 831
E-MAIL: slovenia.info@acv-world.com

UK

ACV UK Ltd
ST. DAVID'S BUSINESS PARK
DALGETY BAY - FIFE - KY11 9PF
TEL.: +44 1383 82 01 00
FAX: +44 1383 82 01 80
E-MAIL: uk.info@acv-world.com

USA

TRIANGLE TUBE PHASE III
FREEWAY CENTER - 1 TRIANGLE LANE
BLACKWOOD NJ 08012 - USA
TEL.: +1 856 228 8881
FAX: +1 856 228 3584
E-MAIL: sales@triangletube.com

NEW ZEALAND

ENERGY PRODUCTS INTERNATIONAL
8/10 BELFAST PLACE
PO BOX 15058 HAMILTON - NEW ZEALAND
TEL.: +64 7 847 27 05
FAX: +64 7 847 42 22
E-MAIL: pmckenzie@tycoint.com

ÖSTERREICH

PROTHERM HEIZUNGSTECHNIK GmbH
TRAUNUFERSTRASSE 113
4052 ANSFELDEN - ÖSTERREICH
TEL.: +43 7229 804 82
FAX: +43 7229 804 92
E-MAIL: protherm@nextra.at

ROMANIA

SC TRUST EURO THERM SA
D.N PIATRA NEAMT - ROMAN
km 2 C.P 5 O.P 3 jud. Neamt
5600 PIATRA NEAMT - ROMANIA
TEL.: +40 233 20 62 06
FAX: +40 233 20 62 00
E-MAIL: office@eurotherm.ro

TUNISIE

SO.CO.ME CHAUMAX
BOÎTE POSTALE N°44
1002 TUNIS - TUNISIE
TEL.: +216 71 78 15 91
FAX: +216 71 78 87 31

UKRAINE

UKRTEPLOSERVICE LTD
PR. LAGUTENKO 14
83086 DONETSK - UKRAINE
TEL.: +38 062 382 60 47/48
FAX: +38 062 335 16 89